

**1M-BIT CMOS STATIC RAM
128K-WORD BY 8-BIT
EXTENDED TEMPERATURE OPERATION**

Description

The μ PD441000L-X is a high speed, low power, 1,048,576 bits (131,072 words by 8 bits) CMOS static RAM.

The μ PD441000L-X has two chip enable pins (/CE1, CE2) to extend the capacity.

- ★ The μ PD441000L-X is packed in 32-pin plastic SOP, 32-pin plastic TSOP (I) and 36-pin plastic FPBGA.

Features

- 131,072 words by 8 bits organization
- Fast access time: 70, 85, 100, 120, 150 ns (MAX.)
- Low voltage operation (B version: $V_{CC} = 2.7$ to 3.6 V, C version: $V_{CC} = 2.2$ to 3.6 V, D version: $V_{CC} = 1.8$ to 3.6 V)
- Operating ambient temperature: $T_A = -25$ to $+85$ °C
- Output Enable input for easy application
- Two Chip Enable inputs: /CE1, CE2

Part number	Access time ns (MAX.)	Operating supply voltage V	Operating ambient temperature °C	Supply current		
				At operating mA (MAX.)	At standby μ A (MAX.)	At data retention μ A (MAX.)
μ PD441000L-BxxX	70, 85, 100	2.7 to 3.6	-25 to +85	25	2	2
μ PD441000L-CxxX	100, 120	2.2 to 3.6				
μ PD441000L-DxxX	120, 150	1.8 to 3.6				

The information in this document is subject to change without notice. Before using this document, please confirm that this is the latest version.
Not all devices/types available in every country. Please check with local NEC representative for availability and additional information.

Ordering Information

Part number	Package	Access time ns (MAX.)	Operating supply voltage V	Operating Temperature °C	Remark
★ μPD441000LGW-B70X	32-pin Plastic SOP (525 mil)	70	2.7 to 3.6	-25 to +85	B Version
★ μPD441000LGW-B85X		85			
★ μPD441000LGW-B10X		100			
★ μPD441000LGW-C10X		100	2.2 to 3.6		C Version
★ μPD441000LGW-C12X		120	1.8 to 3.6		D Version
★ μPD441000LGW-D12X		120			
★ μPD441000LGW-D15X		150			
μPD441000LGU-B70X-9JH	32-pin Plastic TSOP (I) (8 x 13.4 mm) (Normal bent)	70	2.7 to 3.6		B Version
μPD441000LGU-B85X-9JH		85			
μPD441000LGU-B10X-9JH		100			
μPD441000LGU-C10X-9JH		100	2.2 to 3.6		C Version
μPD441000LGU-C12X-9JH		120	1.8 to 3.6		D Version
μPD441000LGU-D12X-9JH		120			
μPD441000LGU-D15X-9JH		150			
μPD441000LGU-B70X-9KH	32-pin Plastic TSOP (I) (8 x 13.4 mm) (Reverse bent)	70	2.7 to 3.6		B Version
μPD441000LGU-B85X-9KH		85			
μPD441000LGU-B10X-9KH		100			
μPD441000LGU-C10X-9KH		100	2.2 to 3.6		C Version
μPD441000LGU-C12X-9KH		120	1.8 to 3.6		D Version
μPD441000LGU-D12X-9KH		120			
μPD441000LGU-D15X-9KH		150			
μPD441000LGZ-B70X-KJH	32-pin Plastic TSOP (I) (8 x 20 mm) (Normal bent)	70	2.7 to 3.6		B Version
μPD441000LGZ-B85X-KJH		85			
μPD441000LGZ-B10X-KJH		100			
μPD441000LGZ-C10X-KJH		100	2.2 to 3.6		C Version
μPD441000LGZ-C12X-KJH		120	1.8 to 3.6		D Version
μPD441000LGZ-D12X-KJH		120			
μPD441000LGZ-D15X-KJH		150			
μPD441000LGZ-B70X-KKH	32-pin Plastic TSOP (I) (8 x 20 mm) (Reverse bent)	70	2.7 to 3.6		B Version
μPD441000LGZ-B85X-KKH		85			
μPD441000LGZ-B10X-KKH		100			
μPD441000LGZ-C10X-KKH		100	2.2 to 3.6		C Version
μPD441000LGZ-C12X-KKH		120	1.8 to 3.6		D Version
μPD441000LGZ-D12X-KKH		120			
μPD441000LGZ-D15X-KKH		150			
★ μPD441000LF1-BA1-B70X ^{Note}	36-pin Plastic FPBGA (6.0 x 6.0 mm)	70	2.7 to 3.6		B Version
★ μPD441000LF1-BA1-B85X ^{Note}		85			
★ μPD441000LF1-BA1-B10X ^{Note}		100			
★ μPD441000LF1-BA1-C10X ^{Note}		100	2.2 to 3.6		C Version
★ μPD441000LF1-BA1-C12X ^{Note}		120	1.8 to 3.6		D Version
★ μPD441000LF1-BA1-D12X ^{Note}		120			
★ μPD441000LF1-BA1-D15X ^{Note}		150			

★ **Note** Under development

Pin Configuration (Marking Side)

/xxx indicates active low signal.

★

32-pin Plastic SOP (525 mil)

[μPD441000LGW-BxxX]

[μPD441000LGW-CxxX]

[μPD441000LGW-DxxX]

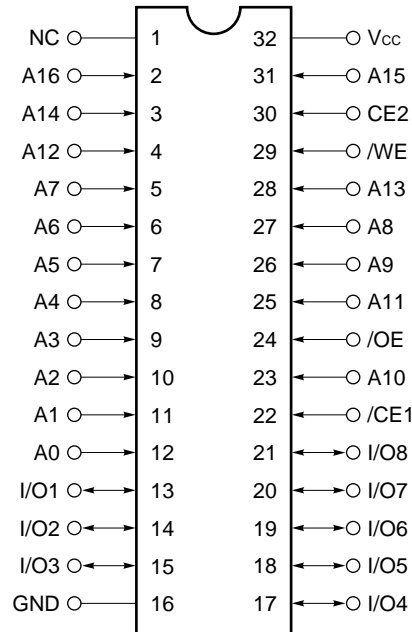

- A0 - A16 : Address inputs
- I/O1 - I/O8 : Data inputs / outputs
- /CE1, CE2 : Chip Enable 1, 2
- /WE : Write Enable
- /OE : Output Enable
- Vcc : Power supply
- GND : Ground
- NC : No connection

32-pin Plastic TSOP (I) (8 x 13.4 mm) (Normal bent)

[μPD441000LGU-BxxX-9JH]

[μPD441000LGU-CxxX-9JH]

[μPD441000LGU-DxxX-9JH]

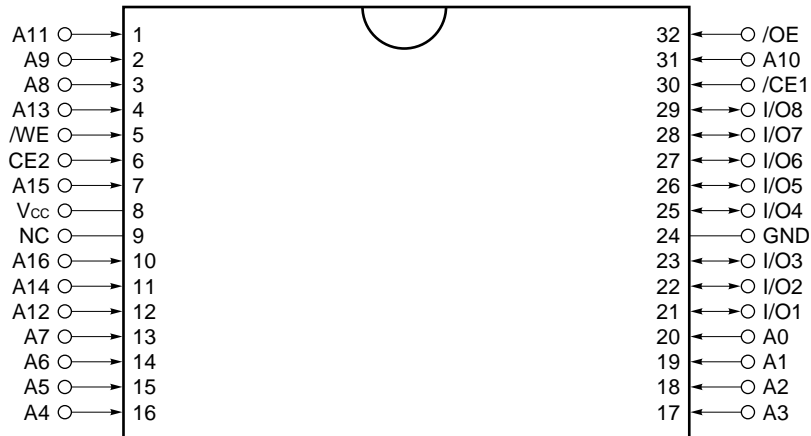

32-pin Plastic TSOP (I) (8 x 13.4 mm) (Reverse bent)

[μPD441000LGU-BxxX-9KH]

[μPD441000LGU-CxxX-9KH]

[μPD441000LGU-DxxX-9KH]

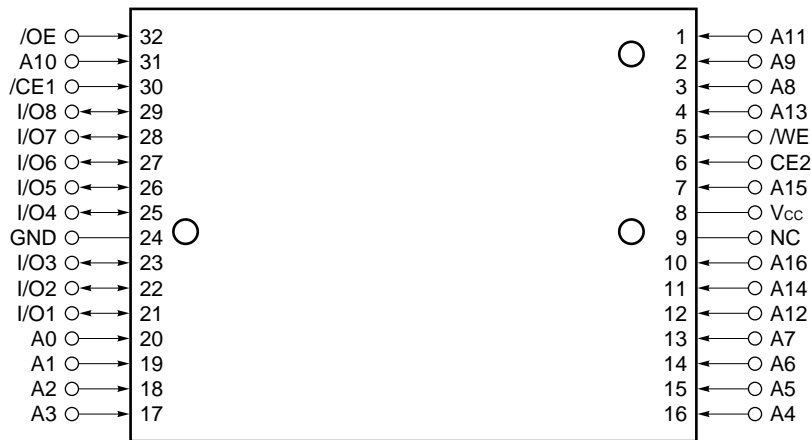

- A0 - A16 : Address inputs
- I/O1 - I/O8 : Data inputs / outputs
- /CE1, CE2 : Chip Enable 1, 2
- /WE : Write Enable
- /OE : Output Enable
- Vcc : Power supply
- GND : Ground
- NC : No connection

32-pin Plastic TSOP (I) (8 x 20 mm) (Normal bent)

[μPD441000LGZ-BxxX-KJH]

[μPD441000LGZ-CxxX-KJH]

[μPD441000LGZ-DxxX-KJH]

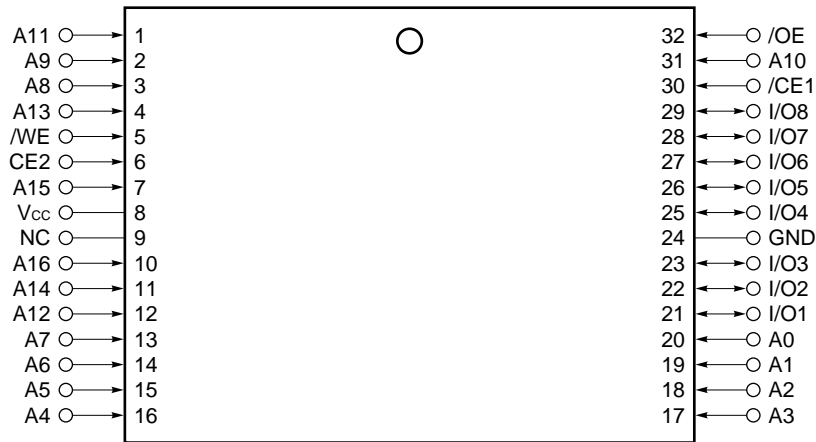

32-pin Plastic TSOP (I) (8 x 20 mm) (Reverse bent)

[μPD441000LGZ-BxxX-KKH]

[μPD441000LGZ-CxxX-KKH]

[μPD441000LGZ-DxxX-KKH]



- A0 - A16 : Address inputs
- I/O1 - I/O8 : Data inputs / outputs
- /CE1, CE2 : Chip Enable 1, 2
- /WE : Write Enable
- /OE : Output Enable
- Vcc : Power supply
- GND : Ground
- NC : No connection

36-pin Plastic FPBGA (6.0 x 6.0 mm)

[μPD441000LF1-BA1-BxxX]

[μPD441000LF1-BA1-CxxX]

[μPD441000LF1-BA1-DxxX]

Top View

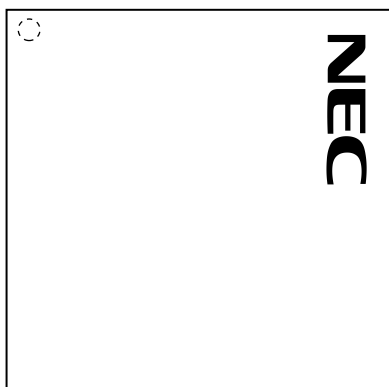

1 2 3 4 5 6

Bottom View

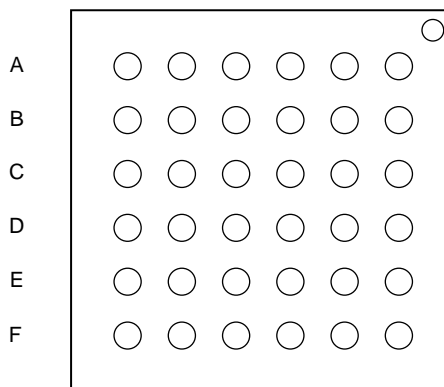

6 5 4 3 2 1

Top view

	1	2	3	4	5	6
A	A7	CE2	Vcc	A15	A13	A11
B	A6	/WE	A16	IC	A8	A9
C	A3	A5	IC	IC	A12	A14
D	/OE	A0	IC	IC	A1	A4
E	/CE1	I/O3	I/O5	I/O6	I/O8	A2
F	I/O1	I/O2	I/O4	GND	I/O7	A10

Bottom view

	6	5	4	3	2	1
A	A11	A13	A15	Vcc	CE2	A7
B	A9	A8	IC	A16	/WE	A6
C	A14	A12	IC	IC	A5	A3
D	A4	A1	IC	IC	A0	/OE
E	A2	I/O8	I/O6	I/O5	I/O3	/CE1
F	A10	I/O7	GND	I/O4	I/O2	I/O1

- A0 - A16 : Address inputs
- I/O1 - I/O8 : Data inputs / outputs
- /CE1, CE2 : Chip Enable 1, 2
- /WE : Write Enable
- /OE : Output Enable
- Vcc : Power supply
- GND : Ground
- IC^{Note} : Internal Connection

Note Leave this pin unconnected or connect to GND.

Block Diagram

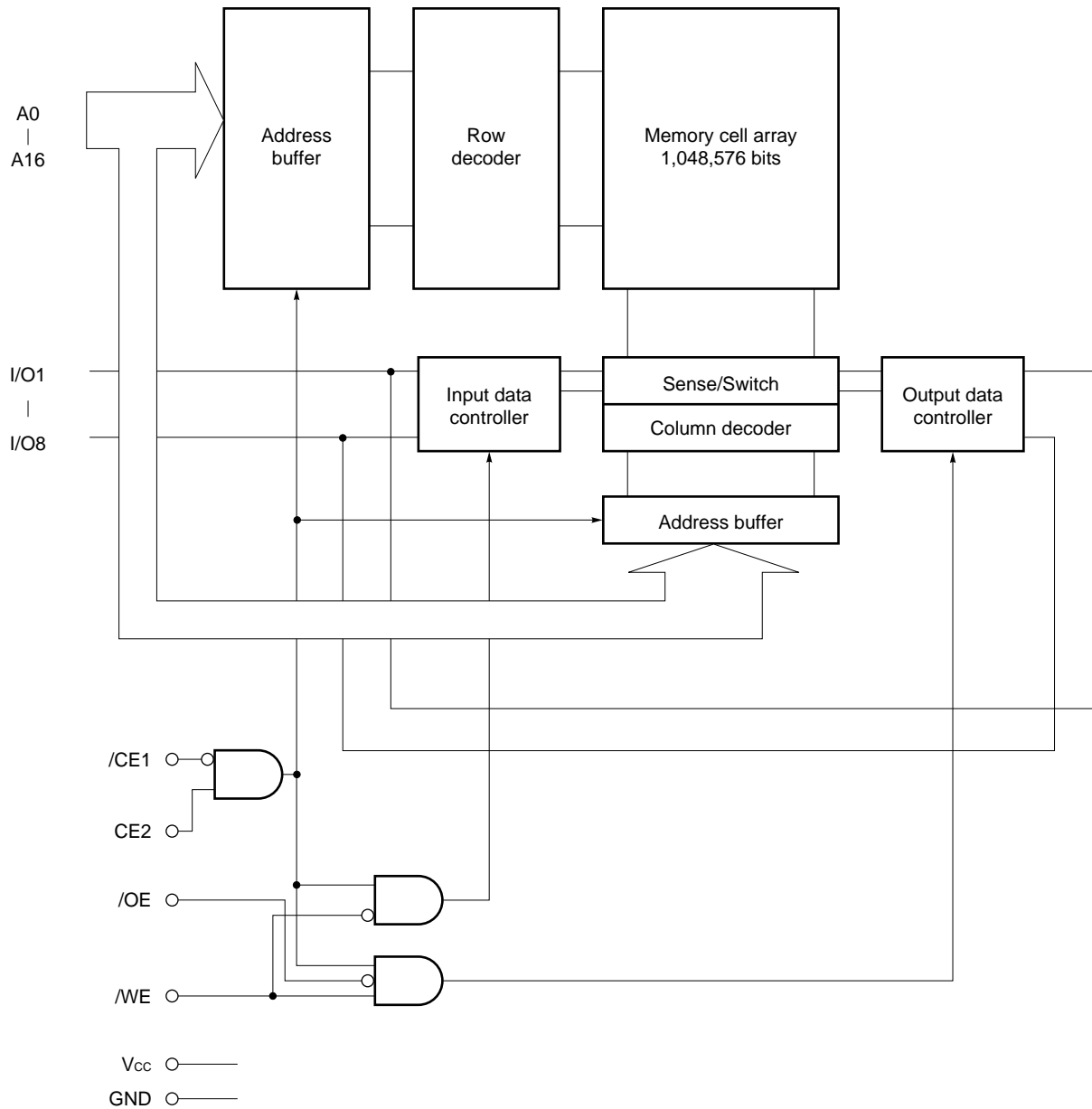

Truth Table

/CE1	CE2	/OE	/WE	Mode	I/O	Supply current
H	x	x	x	Not selected	High impedance	I _{SB}
x	L	x	x			
L	H	H	H	Output disable		I _{CCA}
L	H	L	H	Read	D _{OUT}	
L	H	x	L	Write	D _{IN}	

Remark x: Don't care

Electrical Specifications

Absolute Maximum Ratings

Parameter	Symbol	Condition	Rating	Unit
Supply voltage	V _{CC}		-0.5 ^{Note} to +4.6	V
Input / Output voltage	V _T		-0.5 ^{Note} to V _{CC} +0.5	V
Operating ambient temperature	T _A		-25 to +85	°C
Storage temperature	T _{stg}		-55 to +125	°C

Note -3.0 V (MIN.) (Pulse width: 30 ns)

Caution Exposing the device to stress above those listed in Absolute Maximum Rating could cause permanent damage. The device is not meant to be operated under conditions outside the limits described in the operational section of this specification. Exposure to Absolute Maximum Rating conditions for extended periods may affect device reliability.

Recommended Operating Conditions

Parameter	Symbol	Condition	μPD441000L-BxxX		μPD441000L-CxxX		μPD441000L-DxxX		Unit
			MIN.	MAX.	MIN.	MAX.	MIN.	MAX.	
Supply voltage	V _{CC}		2.7	3.6	2.2	3.6	1.8	3.6	V
High level input voltage	V _{IH}	2.7V ≤ V _{CC} ≤ 3.6V	2.4	V _{CC} +0.5	2.4	V _{CC} +0.5	2.4	V _{CC} +0.5	V
		2.2V ≤ V _{CC} < 2.7V	-	-	2.0	V _{CC} +0.5	2.0	V _{CC} +0.5	
		1.8V ≤ V _{CC} < 2.2V	-	-	-	-	1.6	V _{CC} +0.5	
Low level input voltage	V _{IL}		-0.3 ^{Note}	+0.5	-0.3 ^{Note}	+0.3	-0.3 ^{Note}	+0.2	V
Operating ambient temperature	T _A		-25	+85	-25	+85	-25	+85	°C

Note -3.0 V (MIN.) (Pulse width: 30 ns)

DC Characteristics (Recommended Operating Conditions Unless Otherwise Noted)

Parameter	Symbol	Test condition	μPD441000L-BxxX			μPD441000L-CxxX			μPD441000L-DxxX			Unit	
			MIN.	TYP.	MAX.	MIN.	TYP.	MAX.	MIN.	TYP.	MAX.		
Input leakage current	I _{LI}	V _{IN} = 0 V to V _{CC}	-1.0		+1.0	-1.0		+1.0	-1.0		+1.0	μA	
I/O leakage current	I _{LO}	V _{IO} = 0 V to V _{CC} , /CE1 = V _{IH} or CE2 = V _{IL} or /WE = V _{IL} or /OE = V _{IH}	-1.0		+1.0	-1.0		+1.0	-1.0		+1.0	μA	
Operating supply current	I _{CCA1}	/CE1 = V _{IL} , CE2 = V _{IH} ,		23	25		23	25		23	25	mA	
		Minimum cycle time, I _{I/O} = 0mA	V _{CC} ≤ 2.7 V	—	—		20	23		20	23		
			V _{CC} ≤ 2.2 V	—	—		—	—		17	20		
	I _{CCA2}	/CE1 = V _{IL} , CE2 = V _{IH} ,			5			5			5		
		I _{I/O} = 0mA	V _{CC} ≤ 2.7 V		—			4			4		
			V _{CC} ≤ 2.2 V			—			—				3
	I _{CCA3}	/CE1 ≤ 0.2 V, CE2 ≥ V _{CC} - 0.2 V, Cycle = 1MHz, I _{I/O} = 0 mA, V _{IL} ≤ 0.2 V, V _{IH} ≥ V _{CC} - 0.2 V			4			4			4		
		V _{CC} ≤ 2.7 V			—			3			3		
			V _{CC} ≤ 2.2 V			—			—				3
Standby supply current	I _{SB}	/CE1 = V _{IH} or CE2 = V _{IL}			0.3			0.3			0.3	mA	
		I _{SB1}	/CE1 ≥ V _{CC} - 0.2 V, CE2 ≥ V _{CC} - 0.2 V		0.05	2		0.05	2		0.05		2
	V _{CC} ≤ 2.7 V				—	—		0.04	2		0.04		2
	V _{CC} ≤ 2.2 V				—	—		—	—		0.03		1.5
	I _{SB2}	CE2 ≤ 0.2 V		0.05	2		0.05	2		0.05	2		
			V _{CC} ≤ 2.7 V		—	—		0.04	2		0.04		2
			V _{CC} ≤ 2.2 V		—	—		—	—		0.03		1.5
High level output voltage	V _{OH}	I _{OH} = -0.5 mA		2.4			2.4			2.4		V	
			V _{CC} ≤ 2.7 V		—			1.8			1.8		
			V _{CC} ≤ 2.2 V		—			—			1.5		
Low level output voltage	V _{OL}	I _{OL} = +1.0 mA			0.4			0.4			0.4	V	

Remarks 1. V_{IN}: Input voltage

2. These DC characteristics are in common regardless of package types and access time.

Capacitance (T_A = 25 °C, f = 1 MHz)

Parameter	Symbol	Test condition	MIN.	TYP.	MAX.	Unit
Input capacitance	C _{IN}	V _{IN} = 0 V			6	pF
Input / Output capacitance	C _{I/O}	V _{I/O} = 0 V			10	pF

Remarks 1. V_{IN}: Input voltage

2. These parameters are periodically sampled and not 100% tested.

AC Characteristics (Recommended Operating Conditions Unless Otherwise Noted)

AC Test Conditions

μPD441000L-B70X, μPD441000L-B85X, μPD441000L-B10X

Input Waveform (Rise and Fall Time ≤ 5 ns)

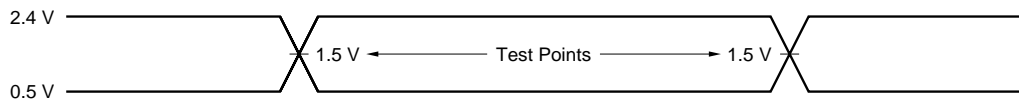

Output Waveform

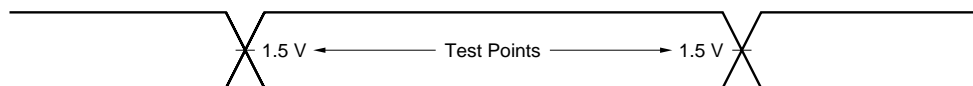

Output Load

1TTL + 50pF

μPD441000L-C10X, μPD441000L-C12X

Input Waveform (Rise and Fall Time ≤ 5 ns)

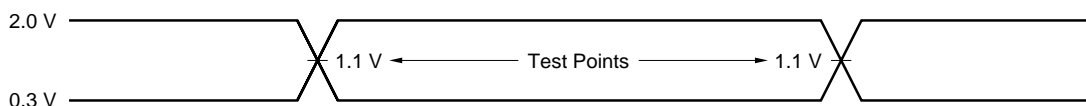

Output Waveform

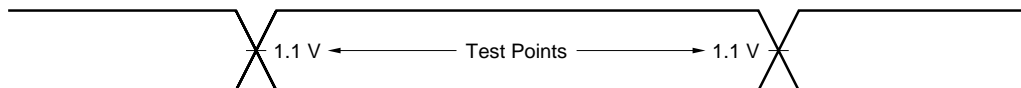

Output Load

1TTL + 30pF

μPD441000L-D12X, μPD441000L-D15X

Input Waveform (Rise and Fall Time ≤ 5 ns)

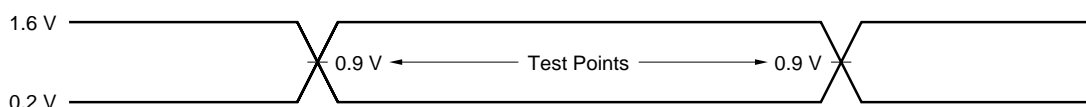

Output Waveform

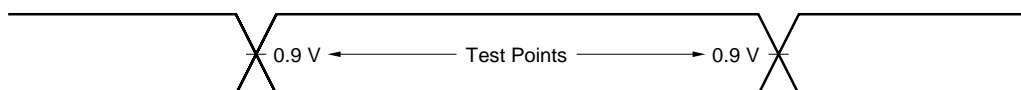

Output Load

1TTL + 30pF

Read Cycle (1/3) (B version)

Parameter	Symbol	μPD441000L-B70X		μPD441000L-B85X		μPD441000L-B10X		Unit	Notes
		MIN.	MAX.	MIN.	MAX.	MIN.	MAX.		
Read cycle time	t _{RC}	70		85		100		ns	
Address access time	t _{AA}		70		85		100	ns	1
/CE1 access time	t _{CO1}		70		85		100	ns	
CE2 access time	t _{CO2}		70		85		100	ns	
/OE to output valid	t _{OE}		35		45		50	ns	
Output hold from address change	t _{OH}	10		10		10		ns	
/CE1 to output in low impedance	t _{LZ1}	10		10		10		ns	2
CE2 to output in low impedance	t _{LZ2}	10		10		10		ns	
/OE to output in low impedance	t _{OLZ}	5		5		5		ns	
/CE1 to output in high impedance	t _{HZ1}		25		30		35	ns	
CE2 to output in high impedance	t _{HZ2}		25		30		35	ns	
/OE to output hold in high impedance	t _{OHZ}		25		30		35	ns	

Notes 1. See the output load.

2. The output load is 1TTL + 5 pF.

Remark These AC characteristics are in common regardless of package types.

Read Cycle (2/3) (C version)

Parameter	Symbol	μPD441000L-C10X		μPD441000L-C12X		Unit	Notes
		MIN.	MAX.	MIN.	MAX.		
Read cycle time	t _{RC}	100		120		ns	
Address access time	t _{AA}		100		120	ns	1
/CE1 access time	t _{CO1}		100		120	ns	
CE2 access time	t _{CO2}		100		120	ns	
/OE to output valid	t _{OE}		50		60	ns	
Output hold from address change	t _{OH}	10		10		ns	
/CE1 to output in low impedance	t _{LZ1}	10		10		ns	2
CE2 to output in low impedance	t _{LZ2}	10		10		ns	
/OE to output in low impedance	t _{OLZ}	5		5		ns	
/CE1 to output in high impedance	t _{HZ1}		35		40	ns	
CE2 to output in high impedance	t _{HZ2}		35		40	ns	
/OE to output hold in high impedance	t _{OHZ}		35		40	ns	

Notes 1. See the output load.

2. The output load is 1TTL + 5 pF.

Remark These AC characteristics are in common regardless of package types.

Read Cycle (3/3) (D version)

Parameter	Symbol	μPD441000L-D12X		μPD441000L-D15X		Unit	Notes
		MIN.	MAX.	MIN.	MAX.		
Read cycle time	t_{RC}	120		150		ns	
Address access time	t_{AA}		120		150	ns	1
/CE1 access time	t_{CO1}		120		150	ns	
CE2 access time	t_{CO2}		120		150	ns	
/OE to output valid	t_{OE}		60		70	ns	
Output hold from address change	t_{OH}	10		10		ns	
/CE1 to output in low impedance	t_{LZ1}	10		10		ns	2
CE2 to output in low impedance	t_{LZ2}	10		10		ns	
/OE to output in low impedance	t_{OLZ}	5		5		ns	
/CE1 to output in high impedance	t_{HZ1}		40		50	ns	
CE2 to output in high impedance	t_{HZ2}		40		50	ns	
/OE to output hold in high impedance	t_{OHZ}		40		50	ns	

- Notes**
1. See the output load.
 2. The output load is 1TTL + 5 pF.

Remark These AC characteristics are in common regardless of package types.

Read Cycle Timing Chart

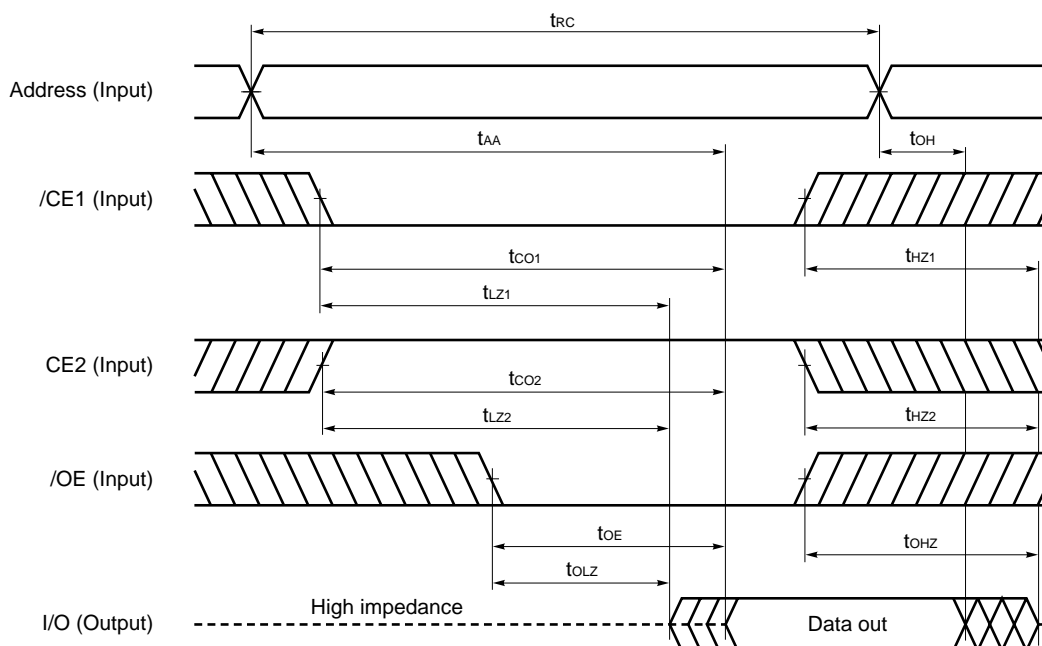

Remark In read cycle, /WE should be fixed to high level.

Write Cycle (1/3) (B version)

Parameter	Symbol	μPD441000L-B70X		μPD441000L-B85X		μPD441000L-B10X		Unit	Note
		MIN.	MAX.	MIN.	MAX.	MIN.	MAX.		
Write cycle time	t _{wc}	70		85		100		ns	
/CE1 to end of write	t _{cw1}	55		70		80		ns	
CE2 to end of write	t _{cw2}	55		70		80		ns	
Address valid to end of write	t _{aw}	55		70		80		ns	
Address setup time	t _{as}	0		0		0		ns	
Write pulse width	t _{wp}	50		60		60		ns	
Write recovery time	t _{wr}	0		0		0		ns	
Data valid to end of write	t _{dw}	35		35		40		ns	
Data hold time	t _{dh}	0		0		0		ns	
/WE to output in high impedance	t _{whz}		25		30		35	ns	1
Output active from end of write	t _{ow}	5		5		5		ns	

Note 1. The output load is 1TTL + 5 pF.

Remark These AC characteristics are in common regardless of package types.

Write Cycle (2/3) (C version)

Parameter	Symbol	μPD441000L-C10X		μPD441000L-C12X		Unit	Note
		MIN.	MAX.	MIN.	MAX.		
Write cycle time	t _{wc}	100		120		ns	
/CE1 to end of write	t _{cw1}	80		100		ns	
CE2 to end of write	t _{cw2}	80		100		ns	
Address valid to end of write	t _{aw}	80		100		ns	
Address setup time	t _{as}	0		0		ns	
Write pulse width	t _{wp}	60		85		ns	
Write recovery time	t _{wr}	0		0		ns	
Data valid to end of write	t _{dw}	45		60		ns	
Data hold time	t _{dh}	0		0		ns	
/WE to output in high impedance	t _{whz}		35		40	ns	1
Output active from end of write	t _{ow}	5		5		ns	

Note 1. The output load is 1TTL + 5 pF.

Remark These AC characteristics are in common regardless of package types.

Write Cycle (3/3) (D version)

Parameter	Symbol	μPD441000L-D12X		μPD441000L-D15X		Unit	Note
		MIN.	MAX.	MIN.	MAX.		
Write cycle time	t _{wc}	120		150		ns	
/CE1 to end of write	t _{cw1}	100		120		ns	
CE2 to end of write	t _{cw2}	100		120		ns	
Address valid to end of write	t _{aw}	100		120		ns	
Address setup time	t _{as}	0		0		ns	
Write pulse width	t _{wp}	85		100		ns	
Write recovery time	t _{wr}	0		0		ns	
Data valid to end of write	t _{dw}	60		80		ns	
Data hold time	t _{dh}	0		0		ns	
/WE to output in high impedance	t _{whz}		40		50	ns	1
Output active from end of write	t _{ow}	5		5		ns	

Note 1. The output load is 1TTL + 5 pF.

Remark These AC characteristics are in common regardless of package types.

Write Cycle Timing Chart 1 (/WE Controlled)

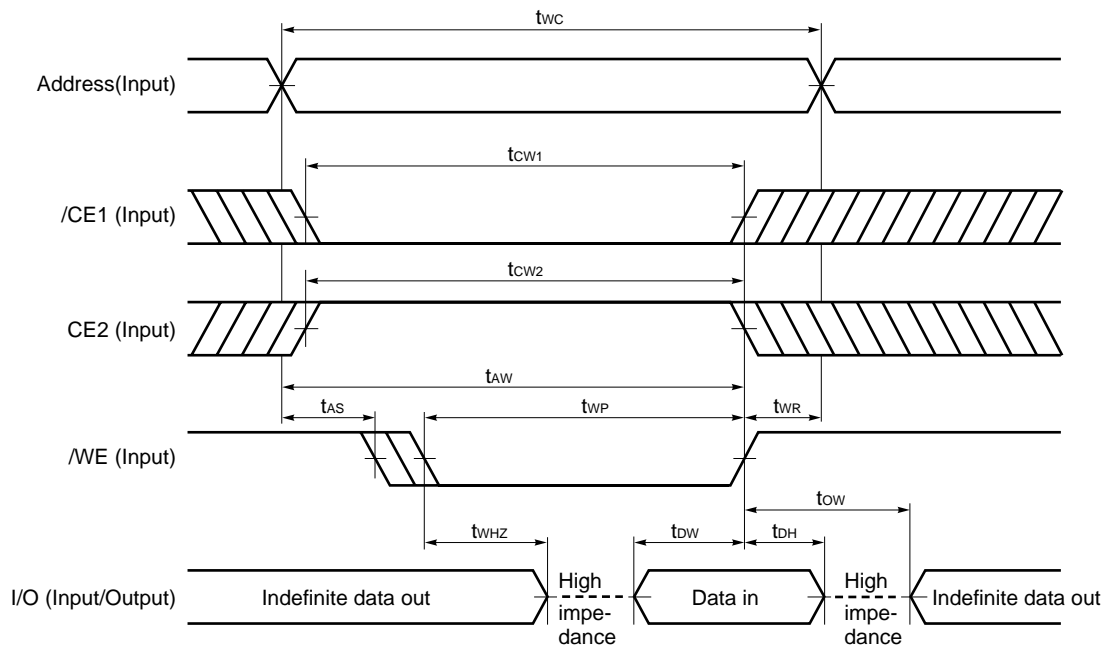

- Cautions**
1. During address transition, at least one of pins /CE1, CE2, /WE should be inactivated.
 2. When I/O pins are in the output state, do not apply to the I/O pins signals that are opposite in phase with output signals.

- Remarks**
1. Write operation is done during the overlap time of a low level /CE1, /WE, and a high level CE2.
 2. If /CE1 changes to low level at the same time or after the change of /WE to low level, or if CE2 changes to high level at the same time or after the change of /WE to low level, the I/O pins will remain high impedance state.
 3. When /WE is at low level, the I/O pins are always high impedance. When /WE is at high level, read operation is executed. Therefore /OE should be at high level to make the I/O pins high impedance.

Write Cycle Timing Chart 2 (/CE1 Controlled)

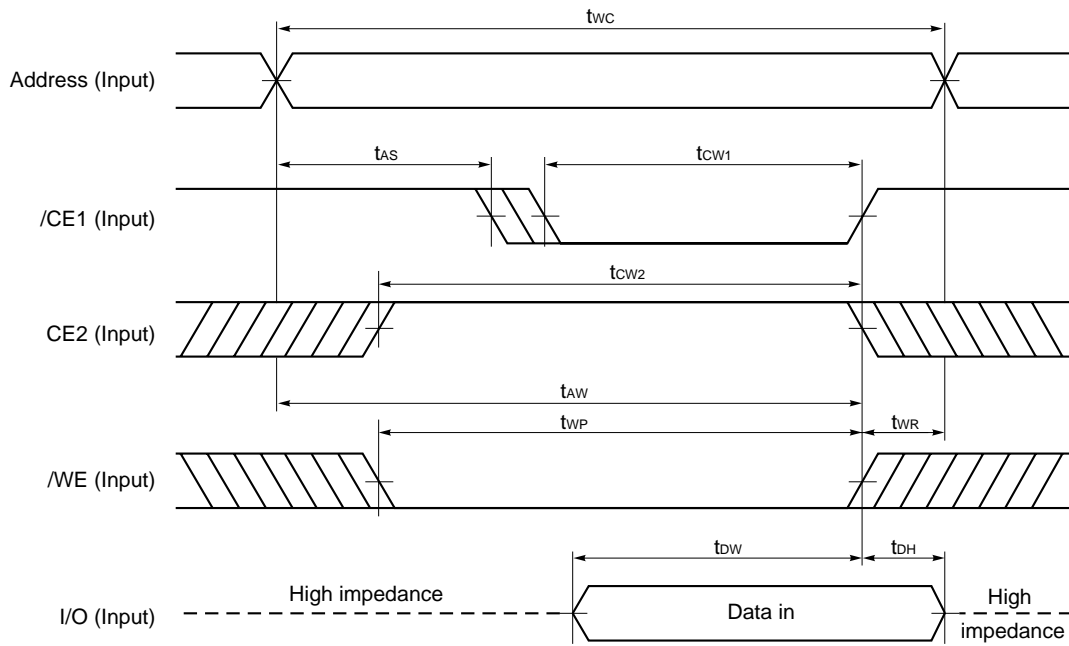

- Cautions**
1. During address transition, at least one of pins /CE1, CE2, /WE should be inactivated.
 2. When I/O pins are in the output state, do not apply to the I/O pins signals that are opposite in phase with output signals.

Remark Write operation is done during the overlap time of a low level /CE1, /WE, and a high level CE2.

Write Cycle Timing Chart 3 (CE2 Controlled)

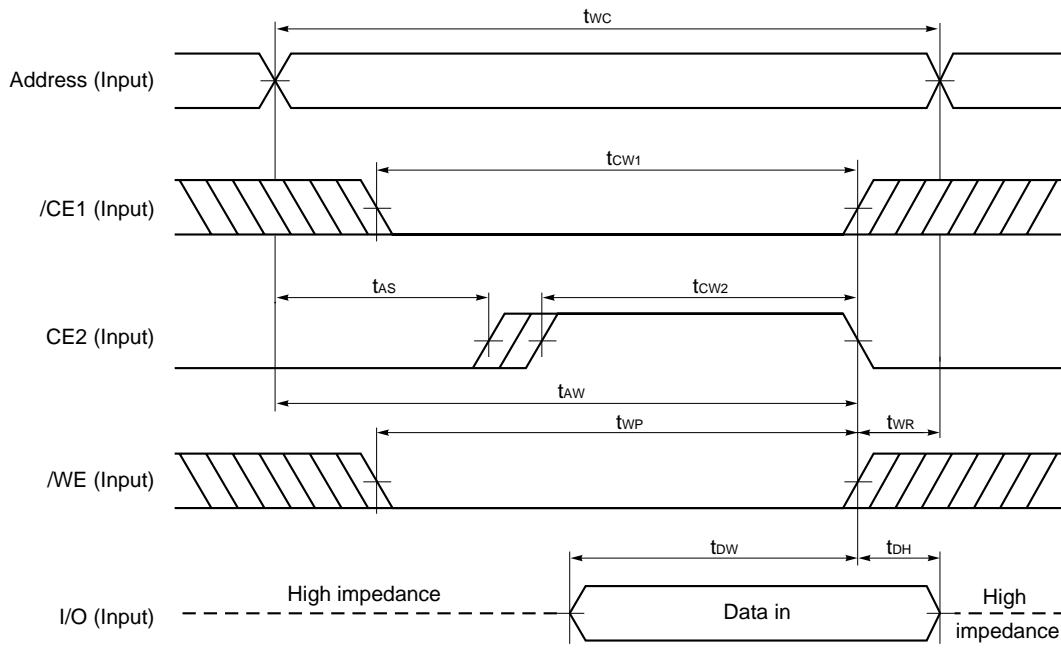

- Cautions**
1. During address transition, at least one of pins /CE1, CE2, /WE should be inactivated.
 2. When I/O pins are in the output state, do not apply to the I/O pins signals that are opposite in phase with output signals.

Remark Write operation is done during the overlap time of a low level /CE1, /WE, and a high level CE2.

Low V_{CC} Data Retention Characteristics

B Version (μPD441000L-BxxX: T_A = -25 to +85 °C)

Parameter	Symbol	Test Conditions	MIN.	TYP.	MAX.	Unit
Data retention supply voltage	V _{CCDR1}	/CE1 ≥ V _{CC} - 0.2 V, CE2 ≥ V _{CC} - 0.2V	2		3.6	V
	V _{CCDR2}	CE2 ≤ 0.2 V	2		3.6	
Data retention supply current	I _{CCDR1}	V _{CC} = 3.0 V, /CE1 ≥ V _{CC} - 0.2 V, CE2 ≥ V _{CC} - 0.2 V or CE2 ≤ 0.2 V		0.05	2 ^{Note}	μA
	I _{CCDR2}	V _{CC} = 3.0 V, CE2 ≤ 0.2 V		0.05	2 ^{Note}	
Chip deselection to data retention mode	t _{CDR}		0			ns
Operation recovery time	t _R		5			ms

Note 0.5 μA (T_A ≤ 40 °C)

C, D Version (μPD441000L-CxxX, μPD441000L-DxxX: T_A = -25 to +85 °C)

Parameter	Symbol	Test Conditions	MIN.	TYP.	MAX.	Unit
Data retention supply voltage	V _{CCDR1}	/CE1 ≥ V _{CC} - 0.2 V, CE2 ≥ V _{CC} - 0.2V	1.5		3.6	V
	V _{CCDR2}	CE2 ≤ 0.2 V	1.5		3.6	
Data retention supply current	I _{CCDR1}	V _{CC} = 3.0 V, /CE1 ≥ V _{CC} - 0.2 V, CE2 ≥ V _{CC} - 0.2 V or CE2 ≤ 0.2 V		0.05	2 ^{Note}	μA
	I _{CCDR2}	V _{CC} = 3.0 V, CE2 ≤ 0.2 V		0.05	2 ^{Note}	
Chip deselection to data retention mode	t _{CDR}		0			ns
Operation recovery time	t _R		5			ms

Note 0.5 μA (T_A ≤ 40 °C)

Data Retention Timing Chart

(1) /CE1 Controlled

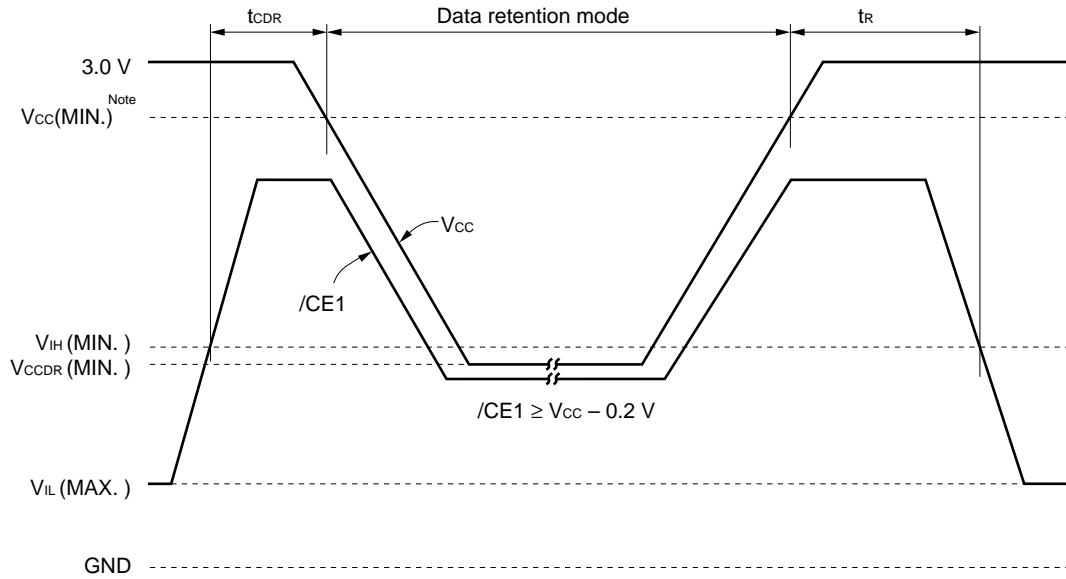

Note B version: 2.7 V, C version: 2.2 V, D version: 1.8 V

Remark On the data retention mode by controlling /CE1, the input level of CE2 must be $CE2 \geq V_{CC} - 0.2 V$ or $CE2 \leq 0.2 V$. The other pins (Address, I/O, /WE, /OE) can be in high impedance state.

(2) CE2 Controlled

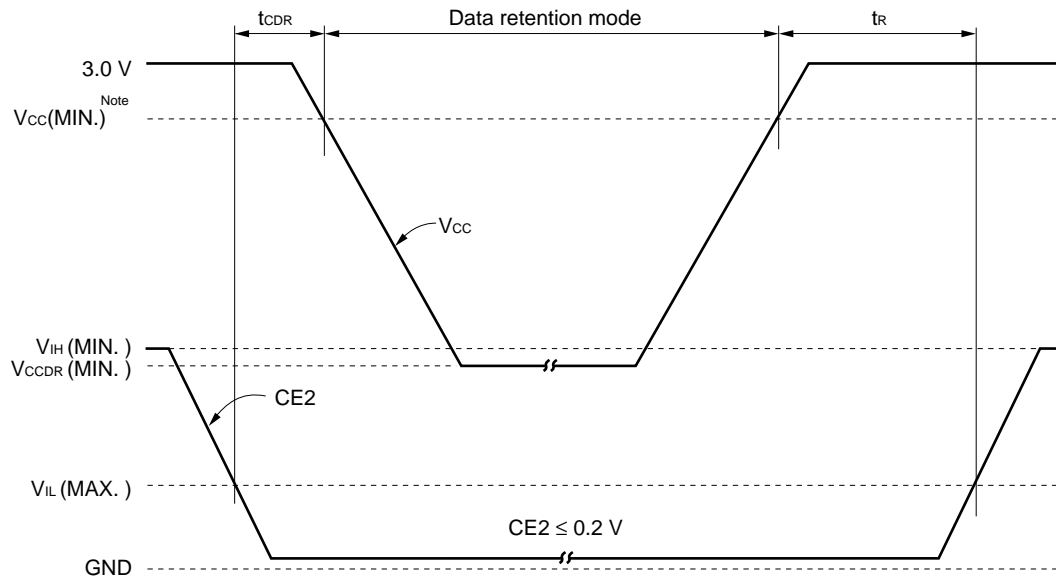

Note B version: 2.7 V, C version: 2.2 V, D version: 1.8 V

Remark The other pins (/CE1, Address, I/O, /WE, /OE) can be in high impedance state.

Package Drawings

★ 32 PIN PLASTIC SOP (525 mil)

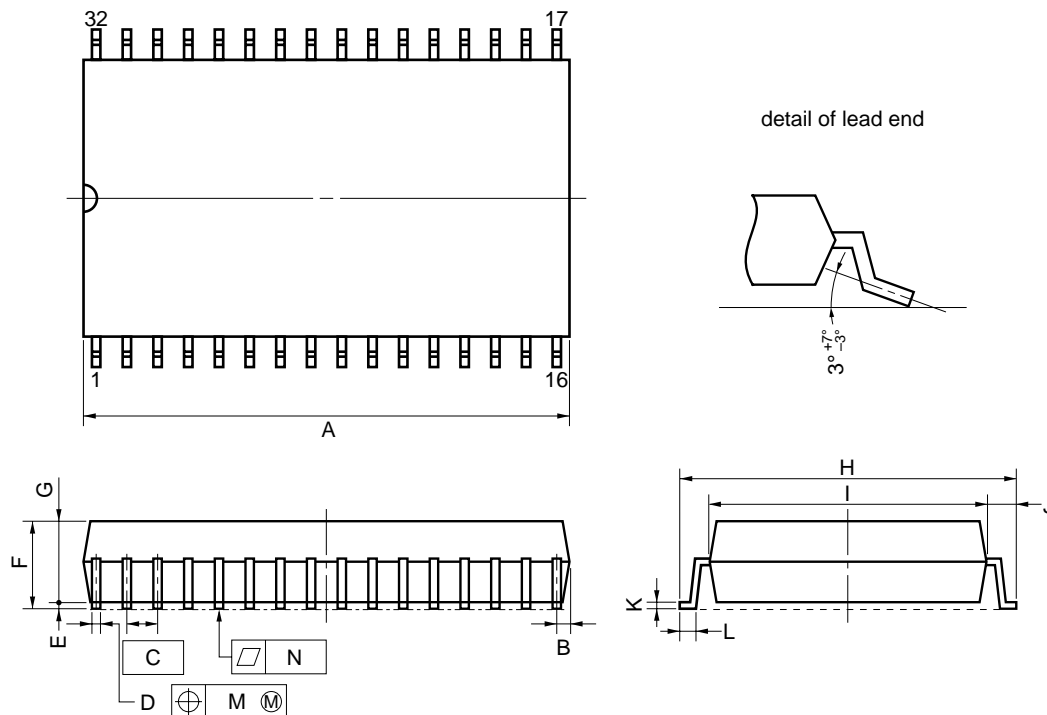

NOTE

Each lead centerline is located within 0.12 mm (0.005 inch) of its true position (T.P.) at maximum material condition.

P32GW-50-525A

ITEM	MILLIMETERS	INCHES
A	20.61 MAX.	0.812 MAX.
B	0.78 MAX.	0.031 MAX.
C	1.27 (T.P.)	0.050 (T.P.)
D	0.40 ^{+0.10} _{-0.05}	0.016 ^{+0.004} _{-0.003}
E	0.15±0.05	0.006
F	2.95 MAX.	0.117 MAX.
G	2.7	0.106
H	14.1±0.3	0.555±0.012
I	11.3	0.445
J	1.4±0.2	0.055±0.008
K	0.20 ^{+0.10} _{-0.05}	0.008 ^{+0.004} _{-0.002}
L	0.8±0.2	0.031 ^{+0.009} _{-0.008}
M	0.12	0.005
N	0.10	0.004

32PIN PLASTIC TSOP (I) (8x13.4)

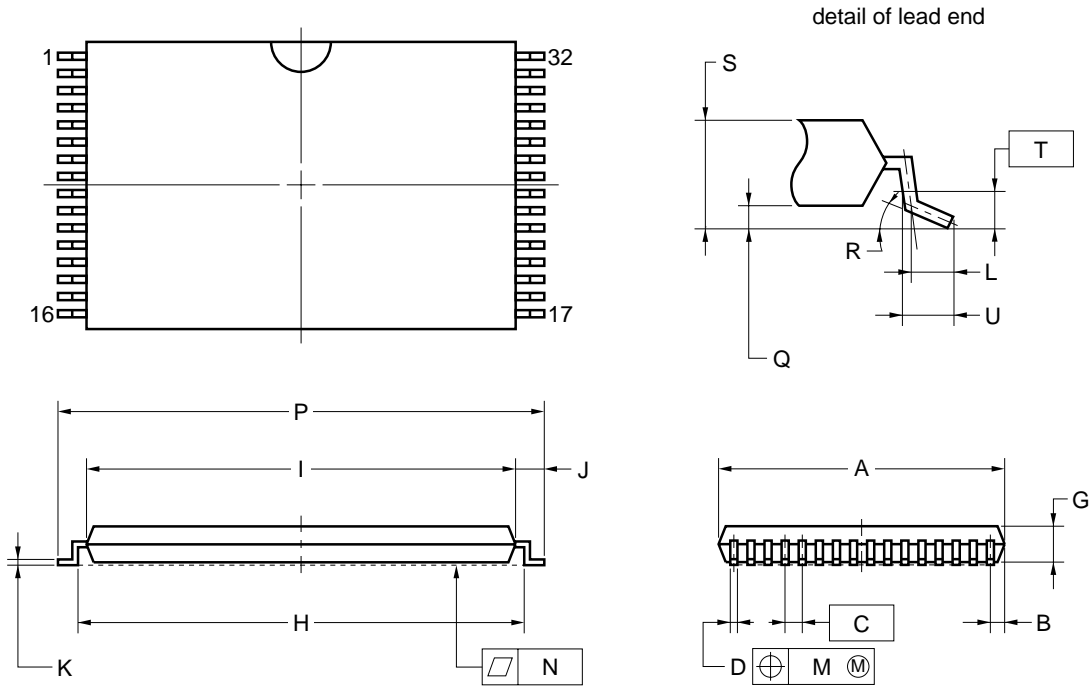

NOTE

- (1) Each lead centerline is located within 0.08 mm (0.003 inch) of its true position (T.P.) at maximum material condition.
- (2) "A" excludes mold flash. (Includes mold flash : 8.3 mm MAX. <0.331 inch MAX.>)

ITEM	MILLIMETERS	INCHES
A	8.0±0.1	0.315±0.004
B	0.45 MAX.	0.018 MAX.
C	0.5 (T.P.)	0.020 (T.P.)
D	0.22±0.05	0.009 ^{+0.002} _{-0.003}
G	1.0±0.05	0.039 ^{+0.003} _{-0.009}
H	12.4±0.2	0.488±0.008
I	11.8±0.1	0.465 ^{+0.004} _{-0.005}
J	0.8±0.2	0.031 ^{+0.009} _{-0.008}
K	0.145 ^{+0.025} _{-0.015}	0.006±0.001
L	0.5	0.020
M	0.08	0.003
N	0.08	0.003
P	13.4±0.2	0.528 ^{+0.008} _{-0.009}
Q	0.1±0.05	0.004±0.002
R	3° ^{+5°} _{-3°}	3° ^{+5°} _{-3°}
S	1.2 MAX.	0.048 MAX.
T	0.25	0.010
U	0.6±0.15	0.024 ^{+0.006} _{-0.007}

P32GU-50-9JH-1

32PIN PLASTIC TSOP (I) (8x13.4)

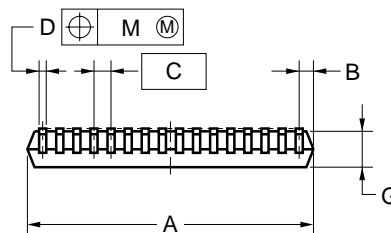
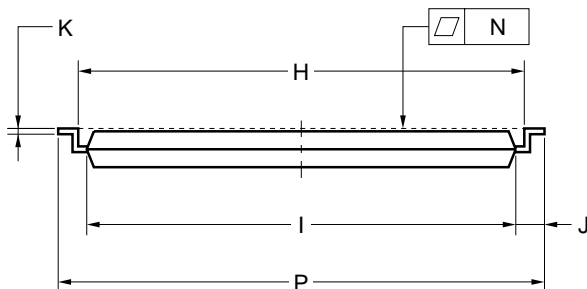
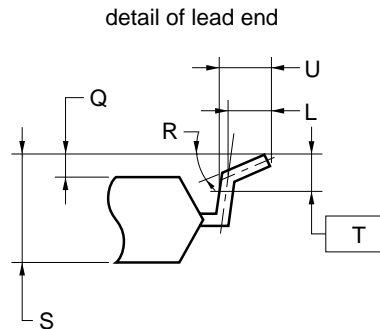
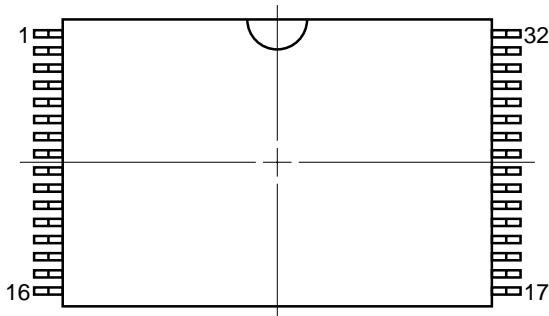

NOTE

- (1) Each lead centerline is located within 0.08 mm (0.003 inch) of its true position (T.P.) at maximum material condition.
- (2) "A" excludes mold flash. (Includes mold flash : 8.3 mm MAX. <0.331 inch MAX.>)

ITEM	MILLIMETERS	INCHES
A	8.0±0.1	0.315±0.004
B	0.45 MAX.	0.018 MAX.
C	0.5 (T.P.)	0.020 (T.P.)
D	0.22±0.05	0.009 ^{+0.002} _{-0.003}
G	1.0±0.05	0.039 ^{+0.003} _{-0.009}
H	12.4±0.2	0.488±0.008
I	11.8±0.1	0.465 ^{+0.004} _{-0.005}
J	0.8±0.2	0.031 ^{+0.009} _{-0.008}
K	0.145 ^{+0.025} _{-0.015}	0.006±0.001
L	0.5	0.020
M	0.08	0.003
N	0.08	0.003
P	13.4±0.2	0.528 ^{+0.008} _{-0.009}
Q	0.1±0.05	0.004±0.002
R	3°+5° -3°	3°+5° -3°
S	1.2 MAX.	0.048 MAX.
T	0.25	0.010
U	0.6±0.15	0.024 ^{+0.006} _{-0.007}

P32GU-50-9KH-1

32 PIN PLASTIC TSOP (I) (8×20)

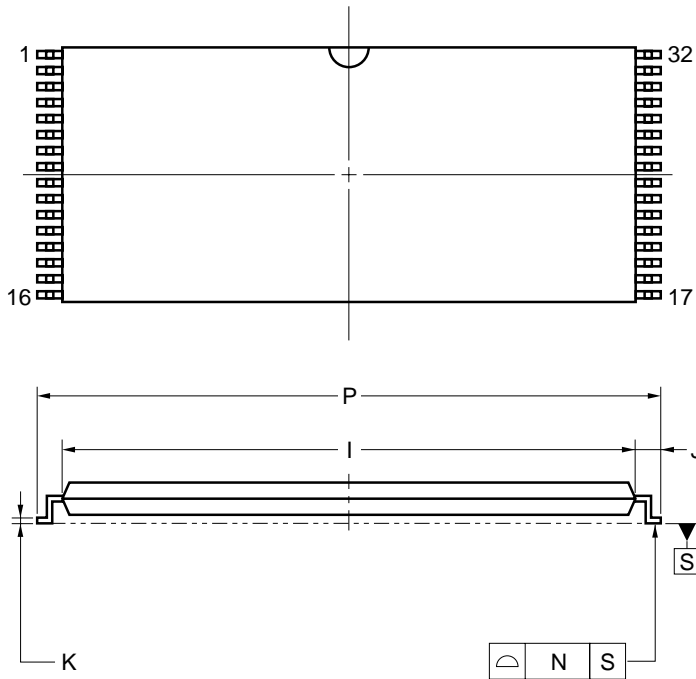

detail of lead end

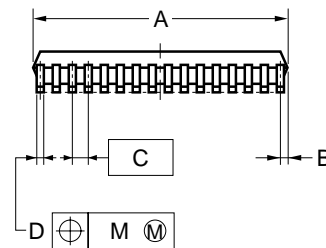
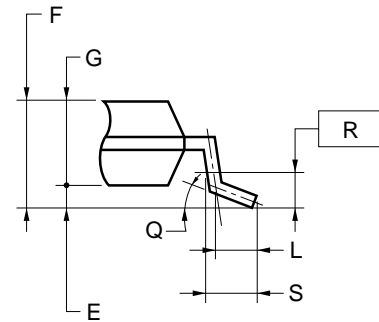

NOTES

1. Controlling dimension — Millimeter.
2. Each lead centerline is located within 0.10 mm (0.004 inch) of its true position (T.P.) at maximum material condition.
3. "A" excludes mold flash. (Includes mold flash : 8.3 mm MAX. <0.327 inch MAX.>)

ITEM	MILLIMETERS	INCHES
A	8.0±0.1	0.315±0.004
B	0.45 MAX.	0.018 MAX.
C	0.5 (T.P.)	0.020 (T.P.)
D	0.22±0.05	0.009 ^{+0.002} _{-0.003}
E	0.1±0.05	0.004±0.002
F	1.2 MAX.	0.048 MAX.
G	0.97±0.08	0.038 ^{+0.004} _{-0.003}
I	18.4±0.1	0.724 ^{+0.005} _{-0.004}
J	0.8±0.2	0.031 ^{+0.009} _{-0.008}
K	0.145±0.05	0.006 ^{+0.002} _{-0.003}
L	0.5	0.020
M	0.10	0.004
N	0.10	0.004
P	20.0±0.2	0.787 ^{+0.009} _{-0.008}
Q	3° ^{+5°} _{-3°}	3° ^{+5°} _{-3°}
R	0.25	0.010
S	0.60±0.15	0.024 ^{+0.006} _{-0.007}

S32GZ-50-KJH1

32 PIN PLASTIC TSOP (I) (8×20)

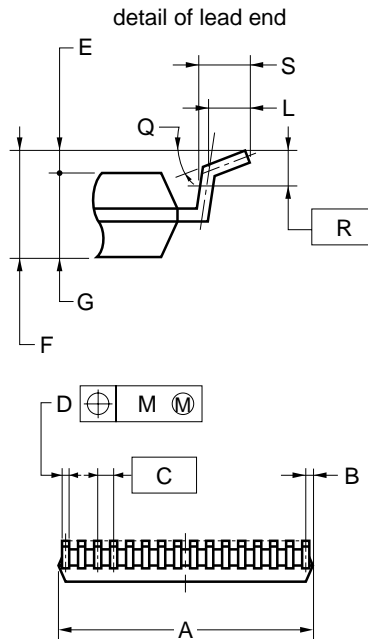
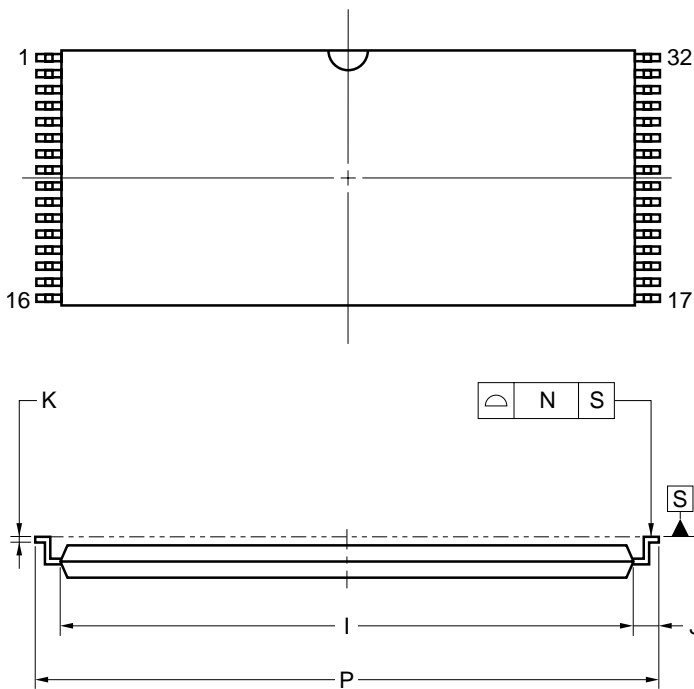

NOTES

1. Controlling dimension — Millimeter.
2. Each lead centerline is located within 0.10 mm (0.004 inch) of its true position (T.P.) at maximum material condition.
3. "A" excludes mold flash. (Includes mold flash : 8.3 mm MAX. <0.327 inch MAX.>).

ITEM	MILLIMETERS	INCHES
A	8.0±0.1	0.315±0.004
B	0.45 MAX.	0.018 MAX.
C	0.5 (T.P.)	0.020 (T.P.)
D	0.22±0.05	0.009 ^{+0.002} _{-0.003}
E	0.1±0.05	0.004±0.002
F	1.2 MAX.	0.048 MAX.
G	0.97±0.08	0.038 ^{+0.004} _{-0.003}
I	18.4±0.1	0.724 ^{+0.005} _{-0.004}
J	0.8±0.2	0.031 ^{+0.009} _{-0.008}
K	0.145±0.05	0.006 ^{+0.002} _{-0.003}
L	0.5	0.020
M	0.10	0.004
N	0.10	0.004
P	20.0±0.2	0.787 ^{+0.009} _{-0.008}
Q	3° ^{+5°} _{-3°}	3° ^{+5°} _{-3°}
R	0.25	0.010
S	0.60±0.15	0.024 ^{+0.006} _{-0.007}

S32GZ-50-KKH1

36 PIN PLASTIC-FPBGA (6.0 × 6.0)

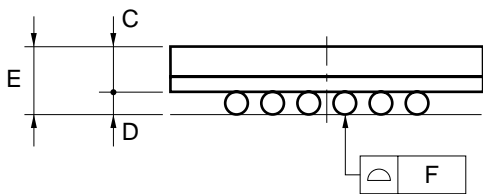
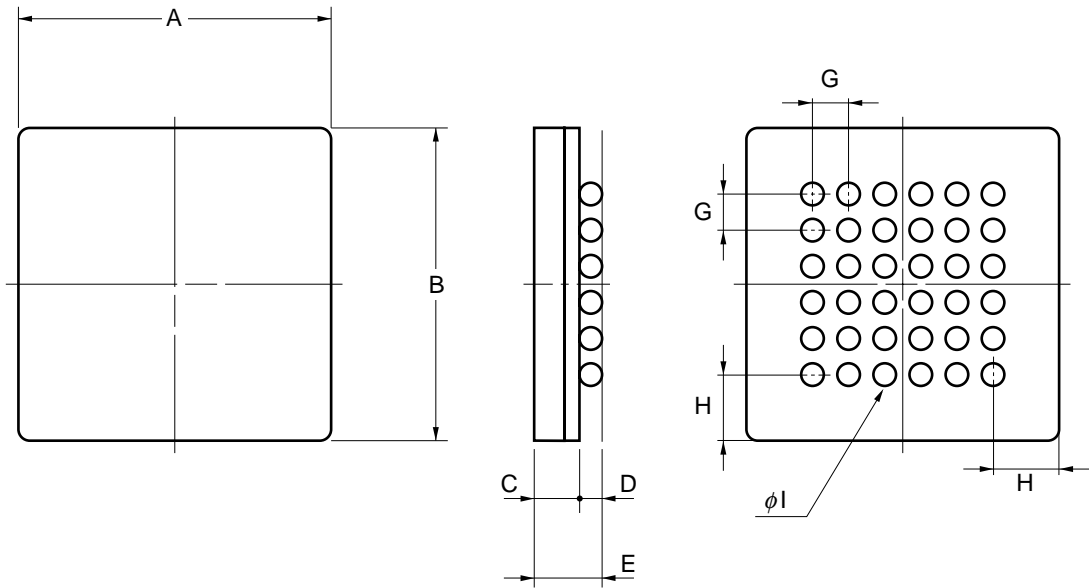

ITEM	MILLIMETERS
A	6.0±0.1
B	6.0±0.1
C	0.68±0.1
D	0.3±0.05
E	1.1 MAX.
F	0.1
G	0.75±0.05
H	1.125
I	0.45±0.05

Recommended Soldering Conditions

Please consult with our sales offices for soldering conditions of the μ PD441000L-X.

Type of Surface Mount Device

- ★ μ PD441000LGW-BX: 32-pin Plastic SOP (525 mil)
- ★ μ PD441000LGW-CX: 32-pin Plastic SOP (525 mil)
- ★ μ PD441000LGW-DX: 32-pin Plastic SOP (525 mil)
- μ PD441000LGU-BX-9JH: 32-pin Plastic TSOP (I) (8 x 13.4 mm) (Normal bent)
- μ PD441000LGU-BX-9KH: 32-pin Plastic TSOP (I) (8 x 13.4 mm) (Reverse bent)
- μ PD441000LGU-CX-9JH: 32-pin Plastic TSOP (I) (8 x 13.4 mm) (Normal bent)
- μ PD441000LGU-CX-9KH: 32-pin Plastic TSOP (I) (8 x 13.4 mm) (Reverse bent)
- μ PD441000LGU-DX-9JH: 32-pin Plastic TSOP (I) (8 x 13.4 mm) (Normal bent)
- μ PD441000LGU-DX-9KH: 32-pin Plastic TSOP (I) (8 x 13.4 mm) (Reverse bent)
- μ PD441000LGZ-BX-KJH: 32-pin Plastic TSOP (I) (8 x 20 mm) (Normal bent)
- μ PD441000LGZ-BX-KKH: 32-pin Plastic TSOP (I) (8 x 20 mm) (Reverse bent)
- μ PD441000LGZ-CX-KJH: 32-pin Plastic TSOP (I) (8 x 20 mm) (Normal bent)
- μ PD441000LGZ-CX-KKH: 32-pin Plastic TSOP (I) (8 x 20 mm) (Reverse bent)
- μ PD441000LGZ-DX-KJH: 32-pin Plastic TSOP (I) (8 x 20 mm) (Normal bent)
- μ PD441000LGZ-DX-KKH: 32-pin Plastic TSOP (I) (8 x 20 mm) (Reverse bent)
- μ PD441000LF1-BA1-BX: 36-pin Plastic FPBGA (6.0 x 6.0 mm)
- μ PD441000LF1-BA1-CX: 36-pin Plastic FPBGA (6.0 x 6.0 mm)
- μ PD441000LF1-BA1-DX: 36-pin Plastic FPBGA (6.0 x 6.0 mm)

NOTES FOR CMOS DEVICES**① PRECAUTION AGAINST ESD FOR SEMICONDUCTORS**

Note:

Strong electric field, when exposed to a MOS device, can cause destruction of the gate oxide and ultimately degrade the device operation. Steps must be taken to stop generation of static electricity as much as possible, and quickly dissipate it once, when it has occurred. Environmental control must be adequate. When it is dry, humidifier should be used. It is recommended to avoid using insulators that easily build static electricity. Semiconductor devices must be stored and transported in an anti-static container, static shielding bag or conductive material. All test and measurement tools including work bench and floor should be grounded. The operator should be grounded using wrist strap. Semiconductor devices must not be touched with bare hands. Similar precautions need to be taken for PW boards with semiconductor devices on it.

② HANDLING OF UNUSED INPUT PINS FOR CMOS

Note:

No connection for CMOS device inputs can be cause of malfunction. If no connection is provided to the input pins, it is possible that an internal input level may be generated due to noise, etc., hence causing malfunction. CMOS devices behave differently than Bipolar or NMOS devices. Input levels of CMOS devices must be fixed high or low by using a pull-up or pull-down circuitry. Each unused pin should be connected to V_{DD} or GND with a resistor, if it is considered to have a possibility of being an output pin. All handling related to the unused pins must be judged device by device and related specifications governing the devices.

③ STATUS BEFORE INITIALIZATION OF MOS DEVICES

Note:

Power-on does not necessarily define initial status of MOS device. Production process of MOS does not define the initial operation status of the device. Immediately after the power source is turned ON, the devices with reset function have not yet been initialized. Hence, power-on does not guarantee out-pin levels, I/O settings or contents of registers. Device is not initialized until the reset signal is received. Reset operation must be executed immediately after power-on for devices having reset function.

[MEMO]

- **The information in this document is subject to change without notice. Before using this document, please confirm that this is the latest version.**
 - No part of this document may be copied or reproduced in any form or by any means without the prior written consent of NEC Corporation. NEC Corporation assumes no responsibility for any errors which may appear in this document.
 - NEC Corporation does not assume any liability for infringement of patents, copyrights or other intellectual property rights of third parties by or arising from use of a device described herein or any other liability arising from use of such device. No license, either express, implied or otherwise, is granted under any patents, copyrights or other intellectual property rights of NEC Corporation or others.
 - Descriptions of circuits, software, and other related information in this document are provided for illustrative purposes in semiconductor product operation and application examples. The incorporation of these circuits, software, and information in the design of the customer's equipment shall be done under the full responsibility of the customer. NEC Corporation assumes no responsibility for any losses incurred by the customer or third parties arising from the use of these circuits, software, and information.
 - While NEC Corporation has been making continuous effort to enhance the reliability of its semiconductor devices, the possibility of defects cannot be eliminated entirely. To minimize risks of damage or injury to persons or property arising from a defect in an NEC semiconductor device, customers must incorporate sufficient safety measures in its design, such as redundancy, fire-containment, and anti-failure features.
 - NEC devices are classified into the following three quality grades:
"Standard", "Special", and "Specific". The Specific quality grade applies only to devices developed based on a customer designated "quality assurance program" for a specific application. The recommended applications of a device depend on its quality grade, as indicated below. Customers must check the quality grade of each device before using it in a particular application.
 - Standard: Computers, office equipment, communications equipment, test and measurement equipment, audio and visual equipment, home electronic appliances, machine tools, personal electronic equipment and industrial robots
 - Special: Transportation equipment (automobiles, trains, ships, etc.), traffic control systems, anti-disaster systems, anti-crime systems, safety equipment and medical equipment (not specifically designed for life support)
 - Specific: Aircraft, aerospace equipment, submersible repeaters, nuclear reactor control systems, life support systems or medical equipment for life support, etc.
- The quality grade of NEC devices is "Standard" unless otherwise specified in NEC's Data Sheets or Data Books. If customers intend to use NEC devices for applications other than those specified for Standard quality grade, they should contact an NEC sales representative in advance.